

LARGE CAPACITY. LOW PROFILE.

REMOTE DISPENSING SYSTEMS

Manually-operated system eliminates hassles associated with CO₂-driven dispensers like squirting and slow discharge when tank runs low

Stainless steel pump serves a 1 oz portion; reduce in 1/8 oz increments to quickly fill soufflé cups

Pouch support accepts both 1 1/2 gallon 16 mm fitment and 3 gallon 38 mm connector pouch styles – twin system includes pouch support racking



The Quick Connect System works with both pouch styles and makes changeouts easy and mess-free

NSF listed, clean-in-place certified; also disassembles completely for dish station cleaning



1.800.558.8722
Server-Products.com



REMOTE DISPENSERS CP-RP Model

Food Applications

- Perfect for schools, stadiums and quick service restaurants where having a large amount of condiments or dressings on tap is important
- Operations looking to speed transaction time; manually operated system can move condiments outside of point-of-purchase – no electricity or CO₂ needed

Fast Facts

At nearly 25% of the cost of CO₂ dispensers, Server's redesigned Remote Dispensing system adapts to both 1.5 gal Cryovac™ pouches with 16 mm fitment and 3 gal Vol-Pak® bag-in-box with 38 mm fitment and eliminates the struggle of changing bulky CO₂ canisters.

Stainless steel pump dispenses 1 ounce (30 mL) max stroke adjustable in 1/8 ounce (3.7 mL) increments to perfectly fill soufflé cups.

A colored and engraved knob identifies condiment below counter. Please specify; black is standard.

The NSF-listed pump is clean-in-place certified and disassembles completely for cleaning at a dish station.

LIKE AN ISLAND OF HIDDEN TOPPING TREASURES

REMOTE DISPENSING SYSTEM

Model CP-RP

Specifier Statement

Server Products Model CP-RP Remote Dispensing System utilizes a manually operated stainless steel pump with modified cast valve to draw from a 1 1/2 gallon (6 L) pouch with 16 mm fitment or 3 gallon (11.4 L) pouch with 38 mm connector of condiments or dressings held in a pouch support below; twin model includes pouch support racking and additional Quick Connector for second pouch. Pump dispenses 1 oz (30 mL) per stroke, adjusts in 1/8 oz (3.7 mL) increments. Colored, engraved knob available upon request; black knob is standard. System installs into countertops up to 1 3/4" (4.4 cm) thick, is BPA Free, NSF listed, clean-in-place certified with a two-year warranty. Ships FOB Richfield, WI 53076.

Remote Dispenser Product Codes

- Single System 85783
- Twin System 85784

Above-Counter Dimensions

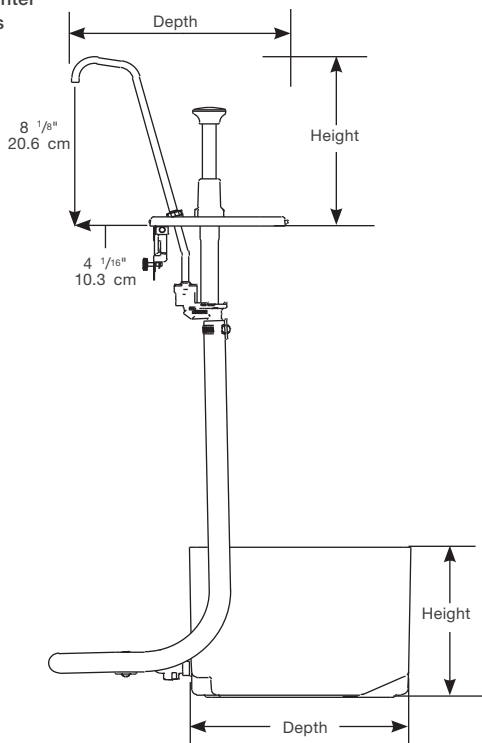

Specifications

85783 Capacity

- (1) 1 1/2 gal (6 L) pouch with 16 mm fitment
- or (1) 3 gal (11.4 L) pouch with 38 mm connector

85784 Capacity

- (1) 1 1/2 gal (6 L) pouch with 16 mm fitment
- or (1) 3 gal (11.4 L) pouch with 38 mm connector
- Racking holds additional pouch for quick change-out

Dim Above Counter: 9 9/16" (24.3 cm) x 4 1/2" (11.4 cm) x 11 3/8" (28.9 cm)

Pouch Support Dim: 8 1/2" (21.6 cm) x 9 1/4" (23.5 cm) x 11 9/16" (29.4 cm)

Twin Dispenser Dim: 12 3/4" (32.4 cm) x 10 3/8" (26.4 cm) x 19 5/16" (49.1 cm)

Weight: 9 lb (4.1 kg) | 18 lb (8.2 kg)

Hose Length: 36" (91.4 cm)



Related Item

The Server Extreme™ dispenses portion-controlled condiments from bag-in-box or Vol-Pak® packaging using an adjustable, ADA compliant lever. The Extreme™ allows you to streamline high-volume operations without the hassle of a CO₂ system and speeds transaction times by creating a self-serve station away from point-of-purchase.



Extreme™ Condiment Dispenser
07500



Open view with pouch



Server Products, Inc. | 800.558.8722 | Intl: 262.628.5600
3601 Pleasant Hill Road | Richfield WI 53076
spsales@server-products.com | server-products.com

Vol-Pak® is a registered trademark of the H.J. Heinz Company
Cryovac™ is a registered trademark and a trade name of Cryovac Inc.
Server Products, Inc. reserves the right to modify specifications without obligation.
Printed in USA | © Server Products, Inc 06.2017 | S 02083